

# SBD Type : EA20QS09

## OUTLINE DRAWING

### FEATURES

- \* TO-251AA Case
- \* Low Forward Voltage drop
- \* Low Power Loss
- \* High Surge Capability
- \* 40 Volts thru 100 Volts Types Available

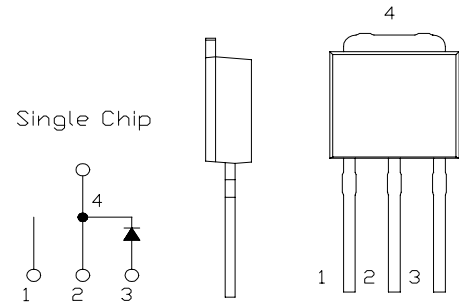

### Maximum Ratings

Approx Net Weight:0.35g

Rating		Symbol	EA20QS09			Unit
Repetitive Peak Reverse Voltage		$V_{RRM}$	90			V
Average Rectified Output Current	P.C.Board mounted *	$I_O$	1.7	$T_a=32^{\circ}C$	50Hz Half Sine Wave Resistive Load	A
	-		1.7	$T_c=139^{\circ}C$		
RMS Forward Current		$I_{F(RMS)}$	2.67			A
Surge Forward Current		$I_{FSM}$	40	50Hz Half Sine Wave, 1cycle, Non-repetitive		A
Operating Junction Temperature Range		$T_{jw}$	- 40 to + 150			$^{\circ}C$
Storage Temperature Range		$T_{stg}$	- 40 to + 150			$^{\circ}C$

### Electrical • Thermal Characteristics

Characteristics		Symbol	Conditions	Min	Typ	Max	Unit
Peak Reverse Current		$I_{RM}$	$T_j=25^{\circ}C, V_{RM}=V_{RRM}$	-	-	1.0	mA
Peak Forward Voltage		$V_{FM}$	$T_j=25^{\circ}C, I_{FM}= 2 A$	-	-	0.85	V
Thermal Resistance	Junction to Ambient	$R_{th(j-a)}$	P.C.Board mounted *	-	-	80	$^{\circ}C/W$
	Junction to Case	$R_{th(j-c)}$	-	-	-	7	$^{\circ}C/W$

\* Print Land = 20x20 mm

EA20QS09 OUTLINE DRAWING (Dimensions in mm)

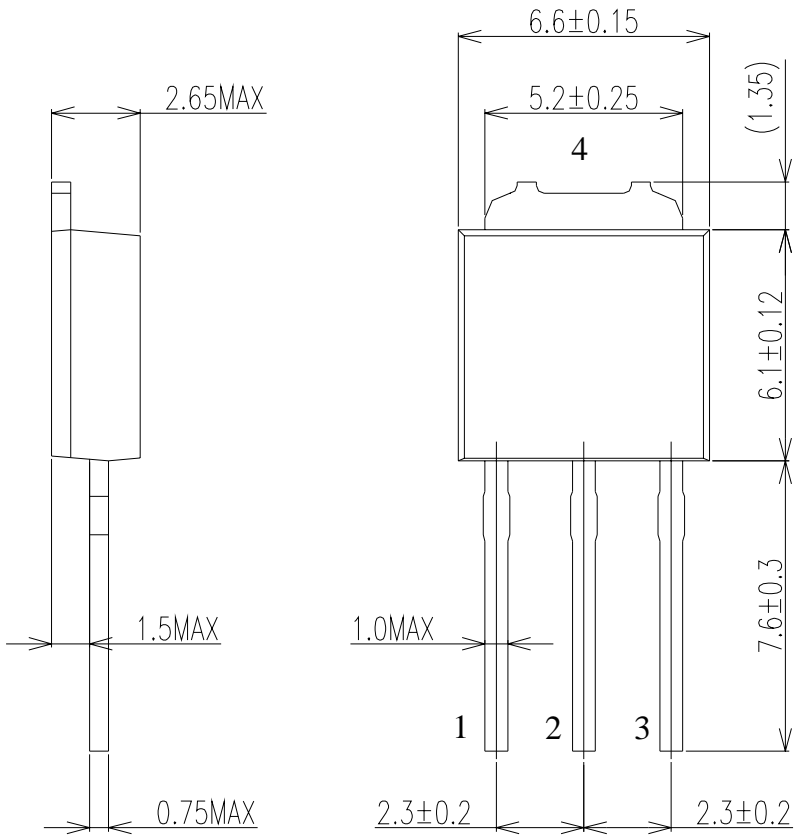

Single

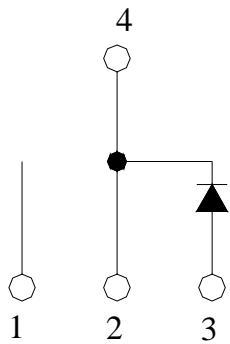

FORWARD CURRENT VS. VOLTAGE



AVERAGE FORWARD POWER DISSIPATION

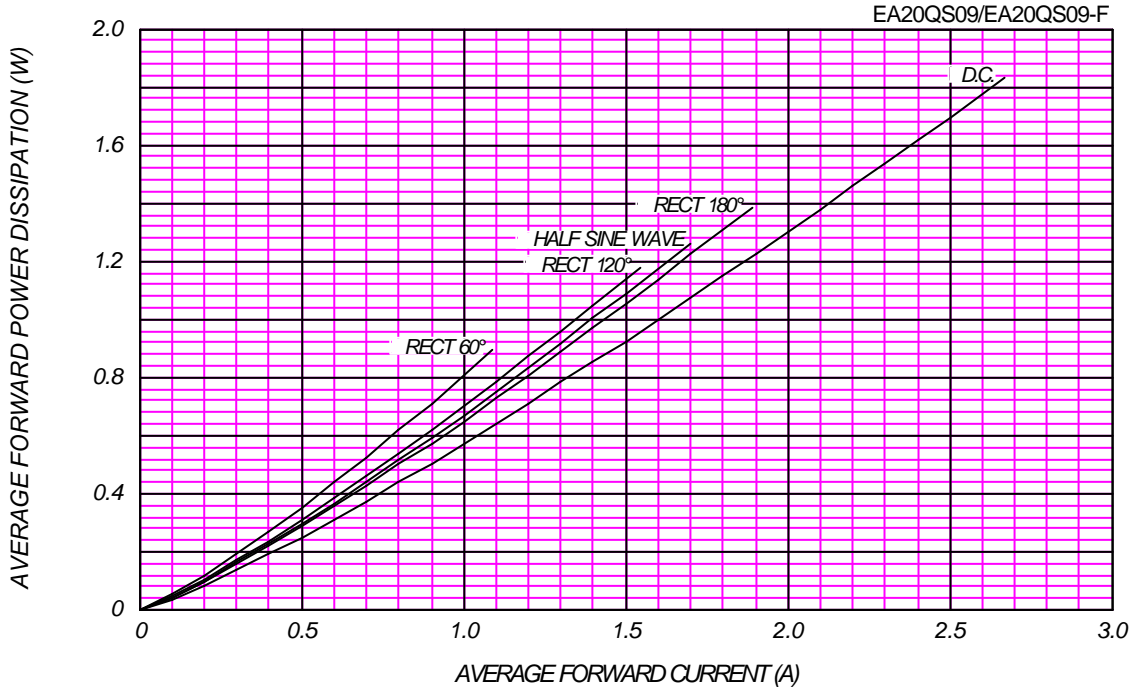

PEAK REVERSE CURRENT VS. PEAK REVERSE VOLTAGE

$T_j = 150\text{ }^\circ\text{C}$

EA20QS09/EA20QS09-F

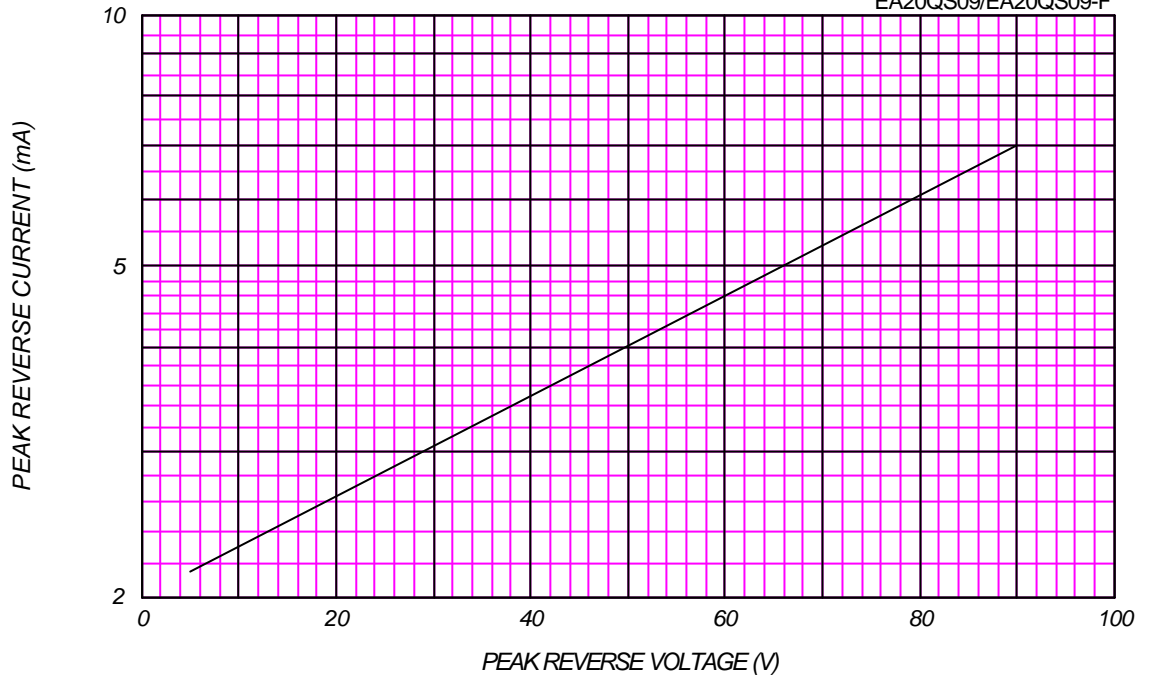

AVERAGE REVERSE POWER DISSIPATION

EA20QS09/EA20QS09-F

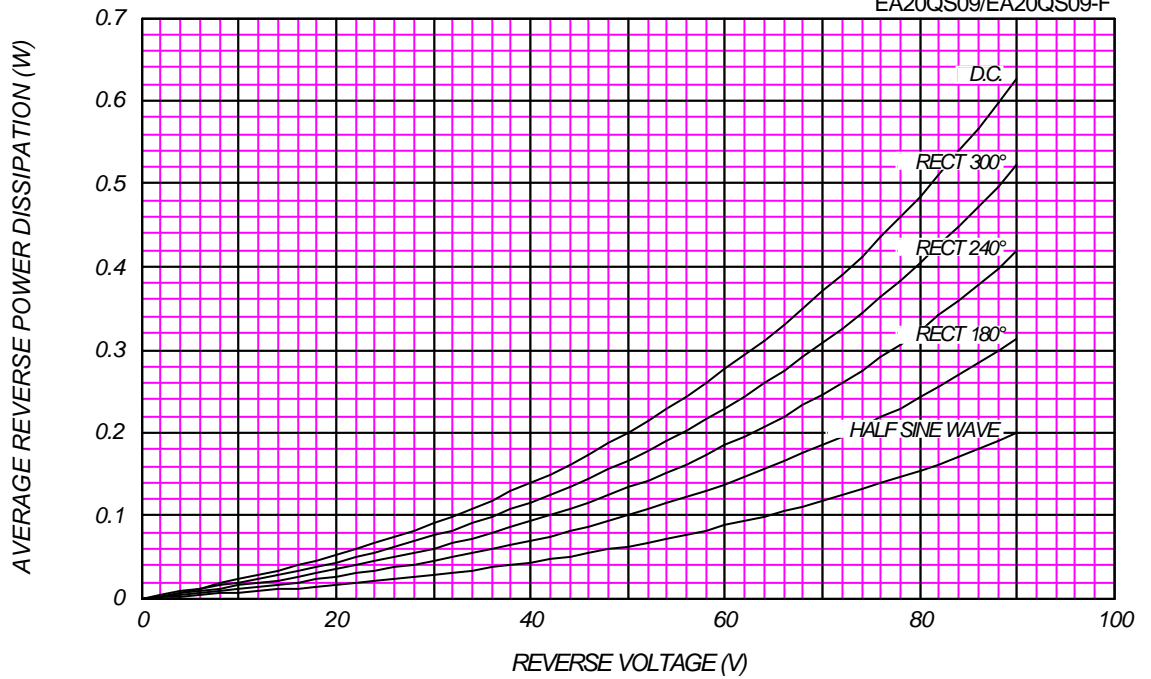



AVERAGE FORWARD CURRENT VS. CASE TEMPERATURE

$V_{RM}=90V$

EA20QS09/EA20QS09-F

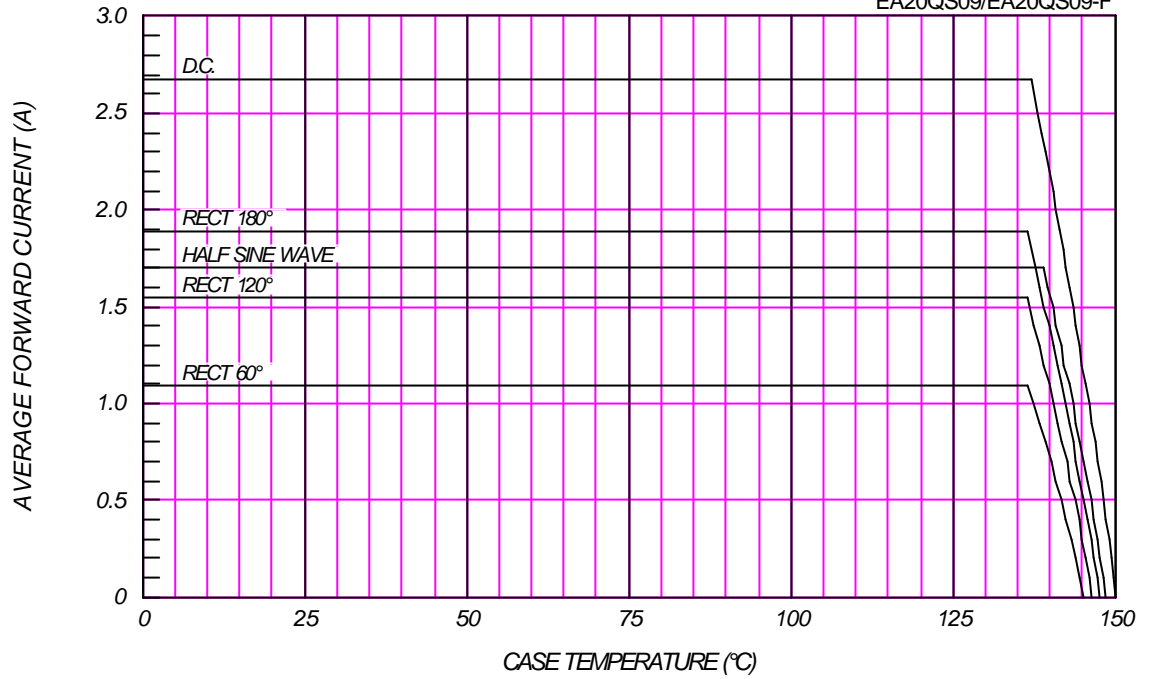

AVERAGE FORWARD CURRENT VS. AMBIENT TEMPERATURE

P.C. Board mounted (Print land=20x20mm)

EA20QS09/EA20QS09-F

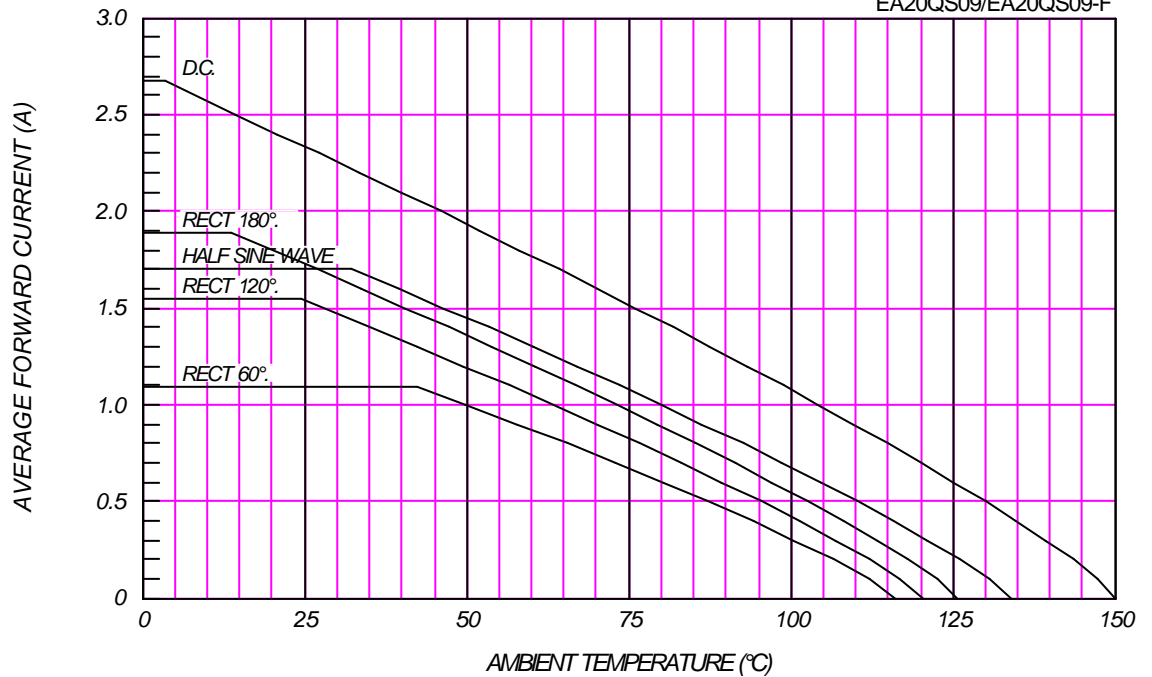

### SURGE CURRENT RATINGS

f=50Hz,Sine Wave,Non-Repetitive,No Load

EA20QS09/EA20QS09-F

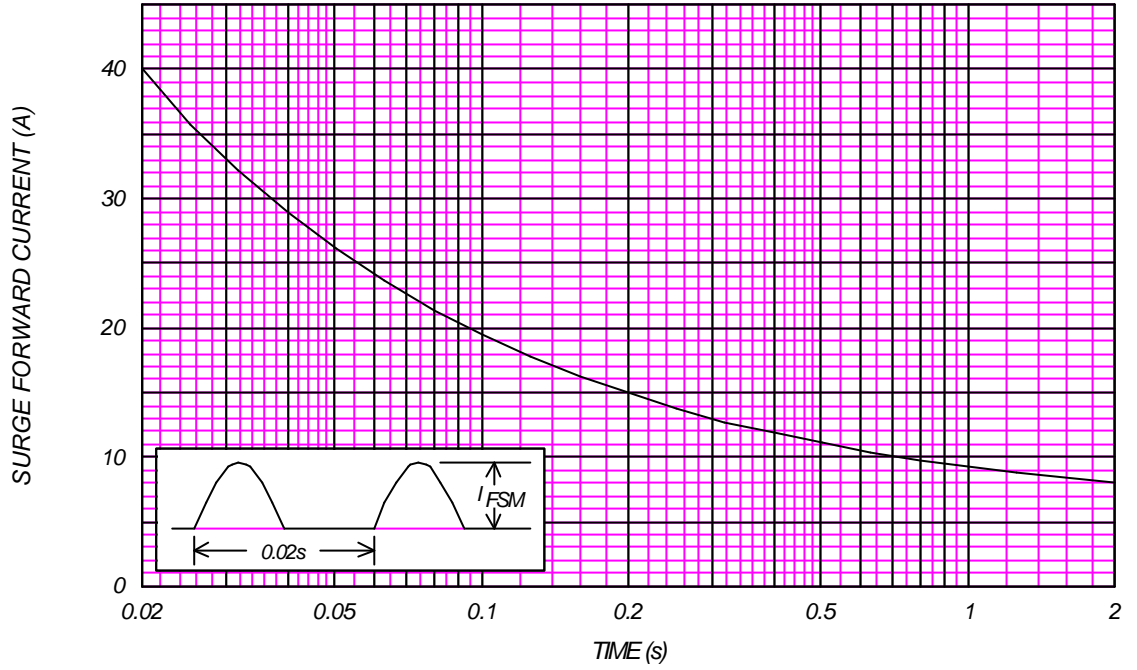

### JUNCTION CAPACITANCE VS. REVERSE VOLTAGE

$T_j=25^\circ\text{C}, V_m=20\text{mV}_{RMS}, f=100\text{kHz}$ , Typical Value

EA20QS09/EA20QS09-F

